

# UMPISOLMU

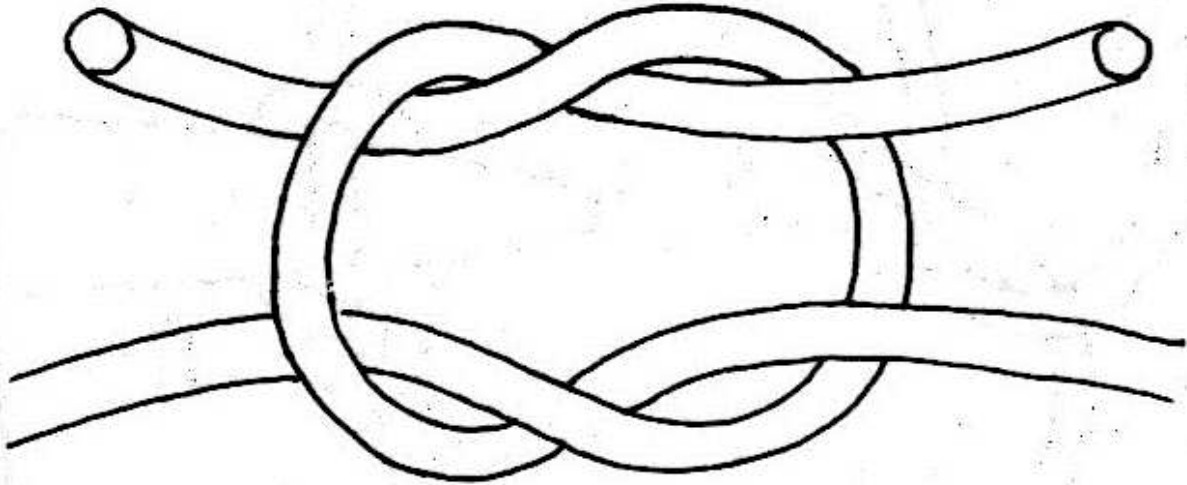

# MERIMIESSOLMU (= REIVISOLMU)



Huomaa, että lyhyet päät ovat samalla puolella! Alla ensin **VARKAANSOLMU**:

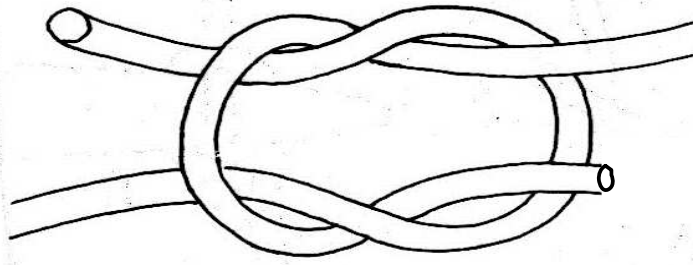

**ÄMMÄNSOLMU** (lyhyet sama puoli)

**MURHESOLMU** (lyhyet eri puoli)

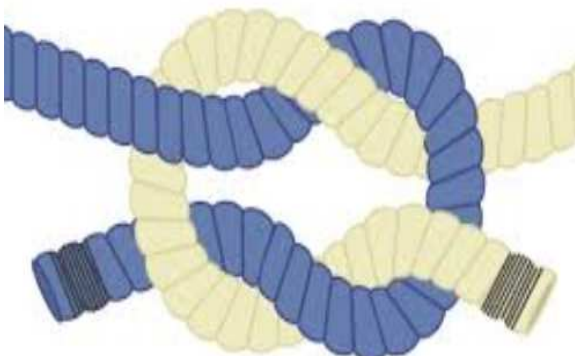

# JALUSSOLMU

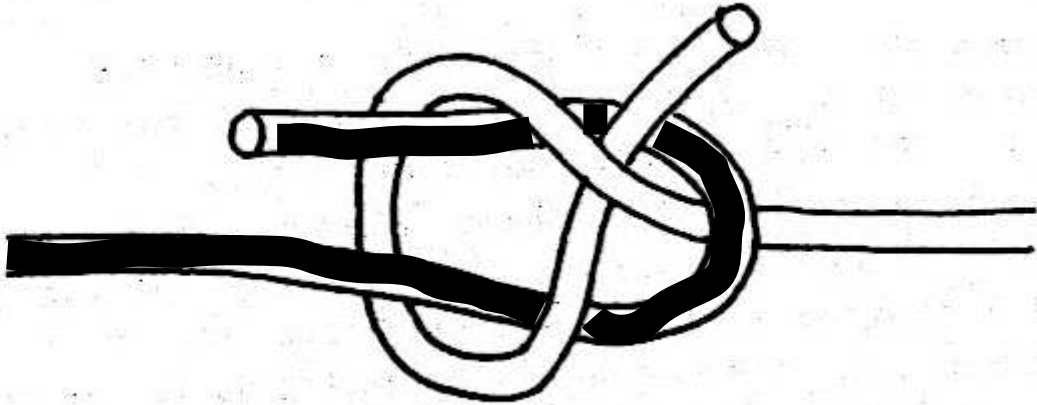

# KERROTTU JALUSSOLMU = LIPPUSOLMU

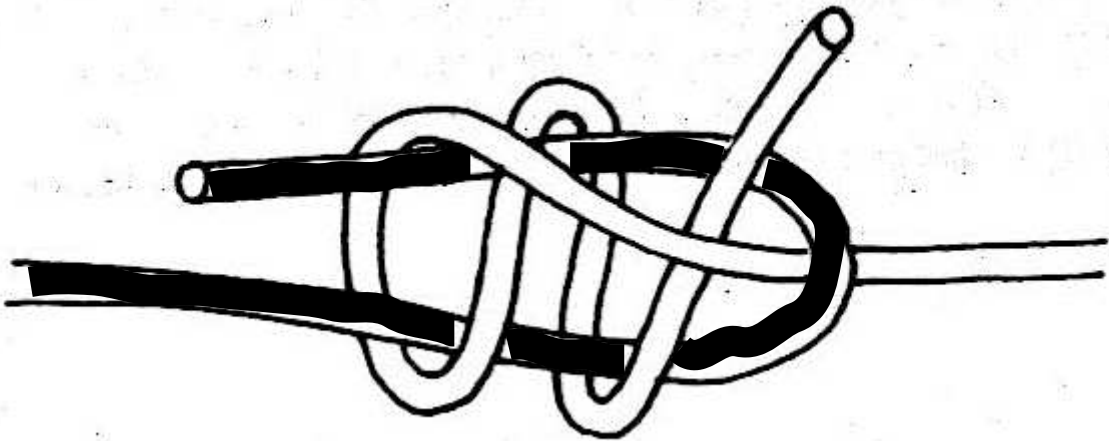

Esim. lipun metallilenkki paksu musta

# KAHDEKSIKKO-SOLMU

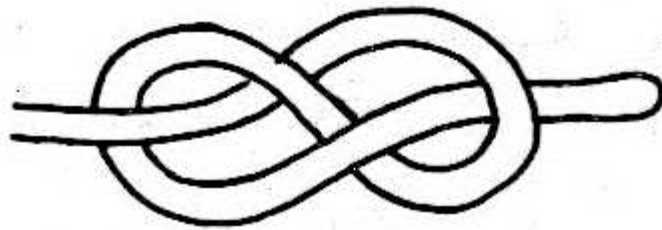

# SIANSORKKA-SOLMU

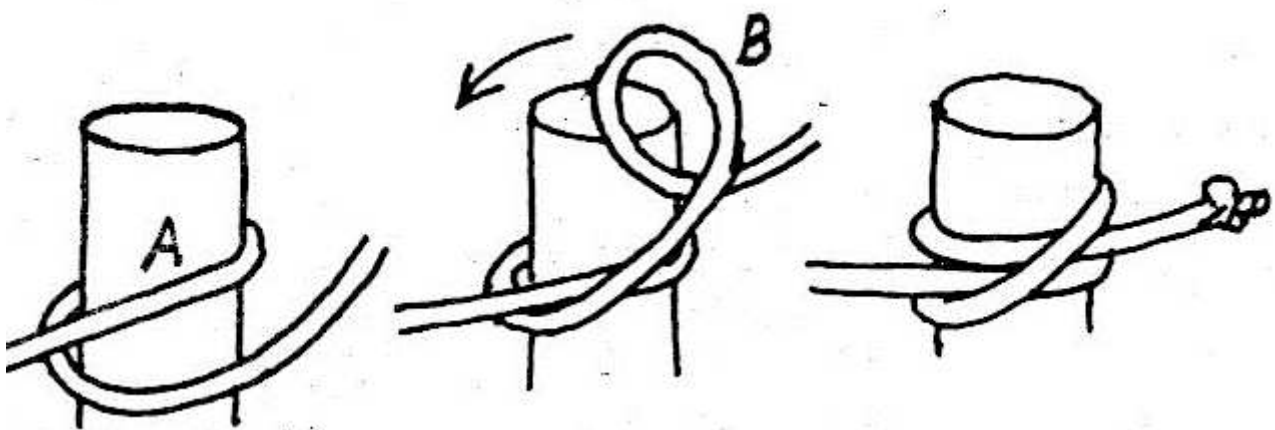
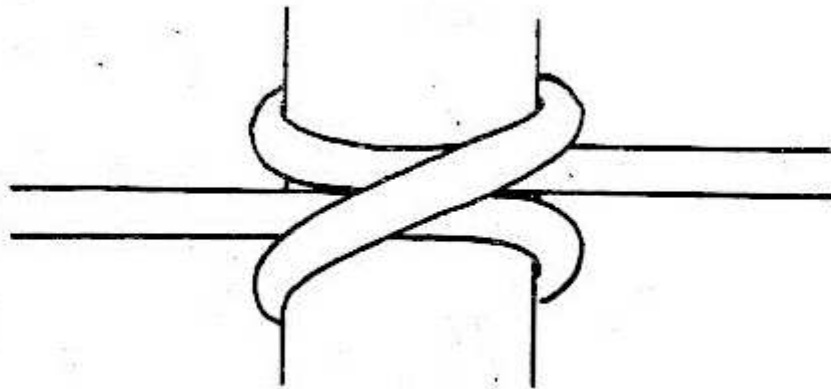

# PAALUSOLMU

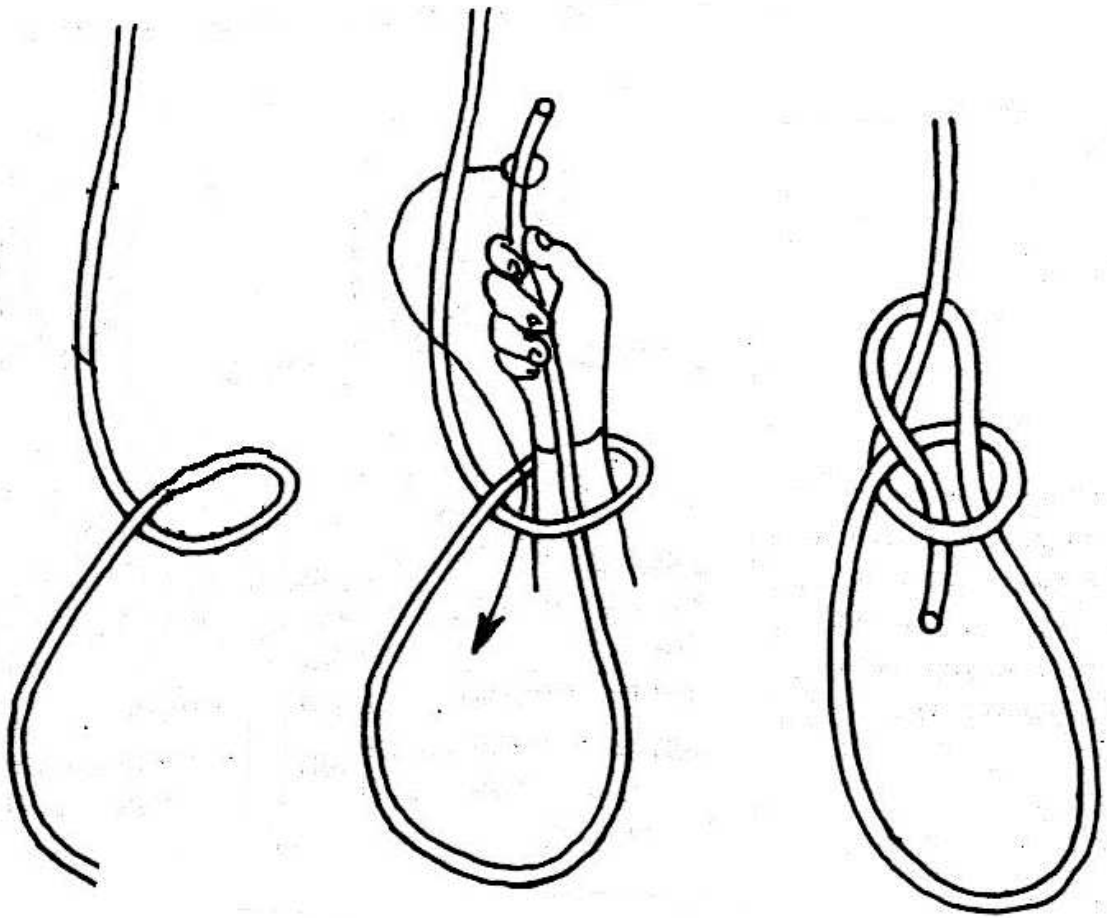

# TUKKIKYTKY

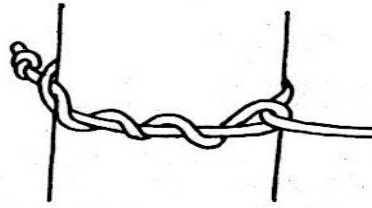

# PUKKIKÖYTÖS (aloita tukkiyksellä)

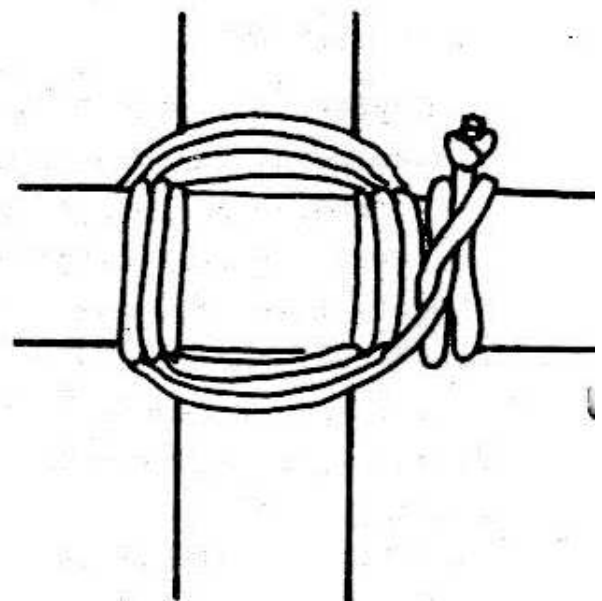
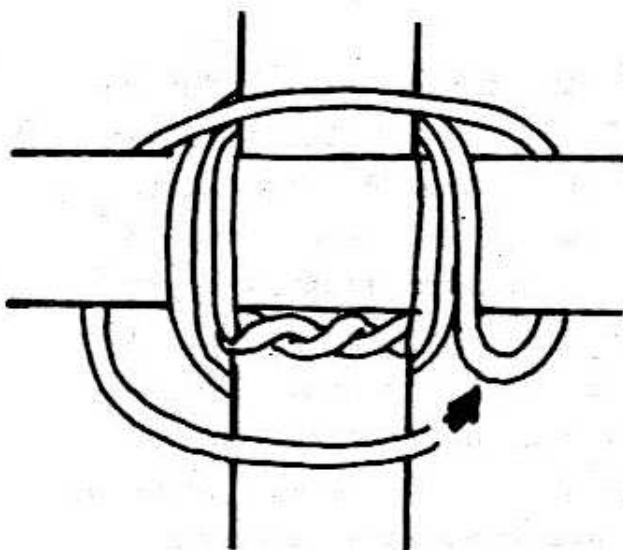
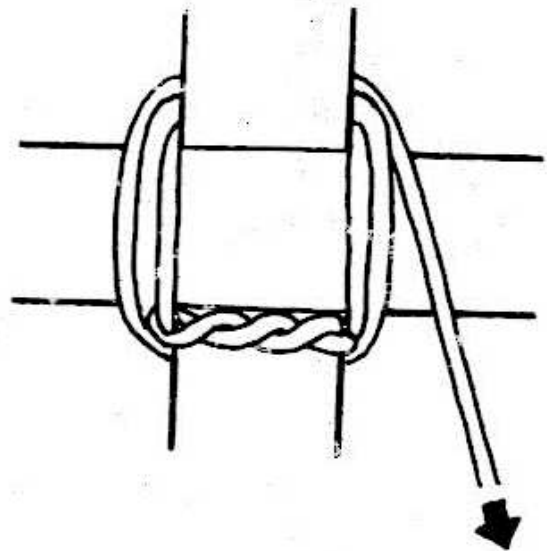
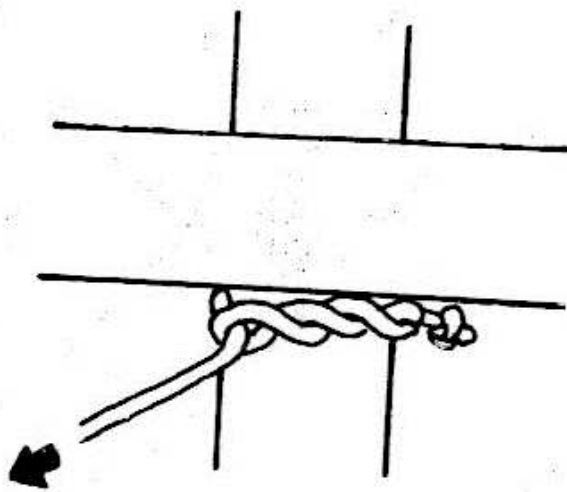

# RISTIKÖYTÖS

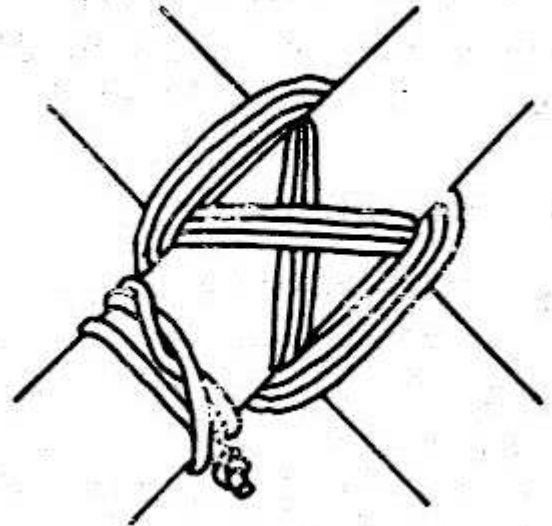
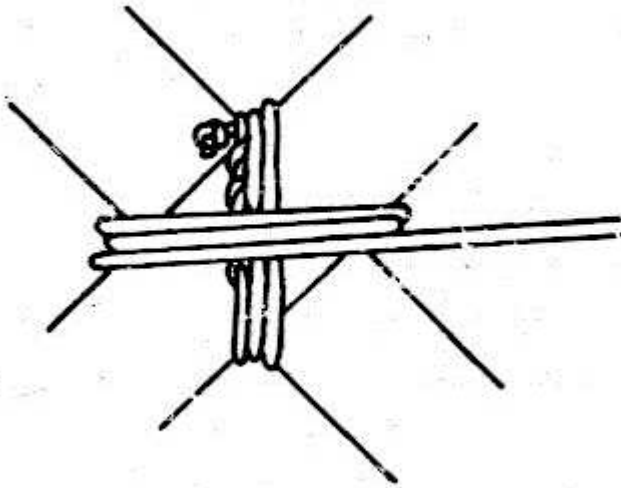
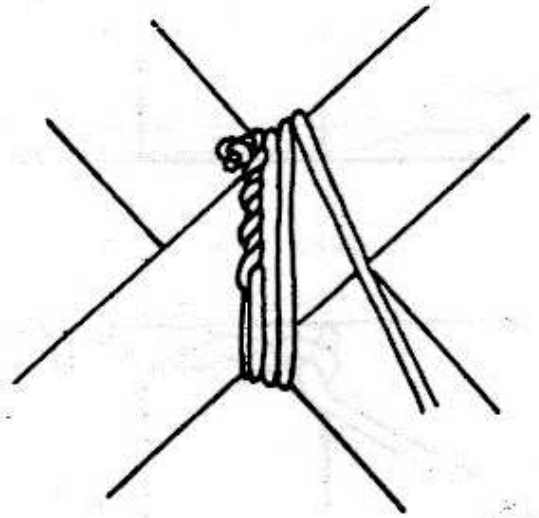
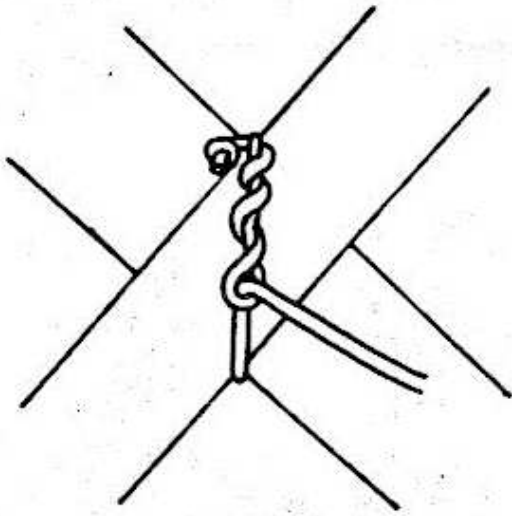

# YHDYSKÖYTÖS

